

Alumno/a:

Dadas las coordenadas diédricas (origen, alejamiento y cota) de los puntos: A, B, C, D, E, F, G, H, I, J, K y L, representa sus proyecciones diédricas y determina la posición de cada uno de ellos, respecto de la línea de tierra, planos de proyección, planos bisectores y octantes.

A: 10, 10, 30
 B: 20, 30, 10
 C: 30, 30, 30
 D: 40, 00, 35

E: 10, -30, 20
 F: 20, -20, 0
 G: 30, -35, 35
 H: 40, -20, 30



I: 10, 0, -30
 J: 20, -35, -20
 K: 30, -20, -20
 L: 40, -20, -30

M: 10, 30, -20
 N: 20, 25, -25
 O: 30, 10, 0
 P: 40, 0, 0



POSICIÓN DE LOS PUNTOS:

| | |
|----|----|
| A: | I: |
| B: | J: |
| C: | K: |
| D: | L: |
| E: | M: |
| F: | N: |
| G: | O: |
| H: | P: |

Alumno/a:

Hallar las trazas y representar las partes vistas y ocultas de las siguientes rectas

1

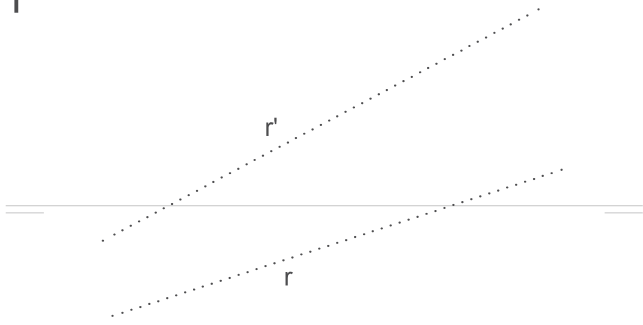

2

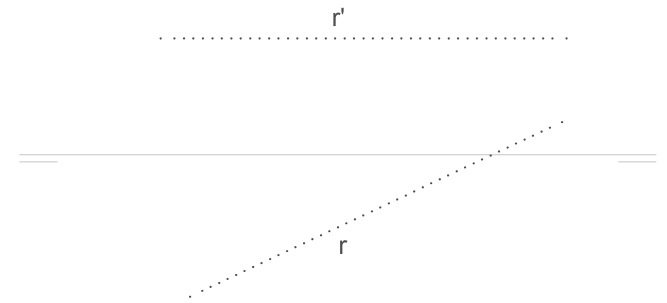

3

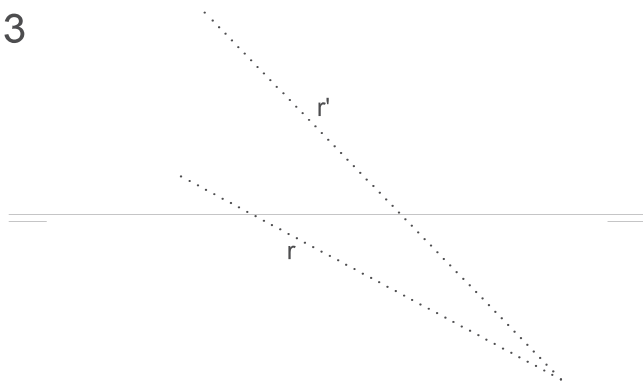

4

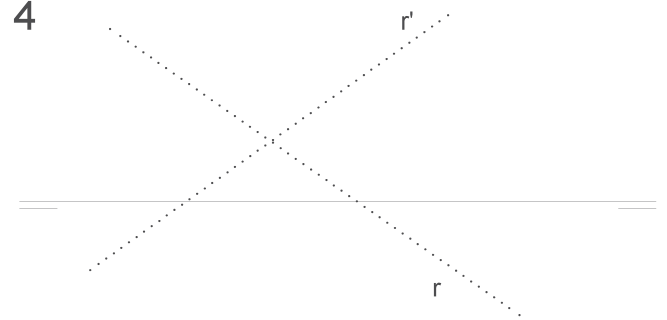

5

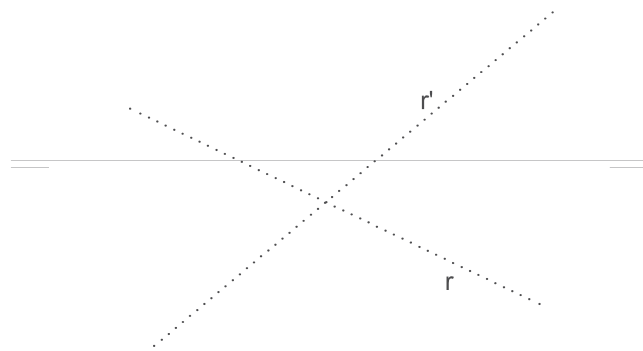

6

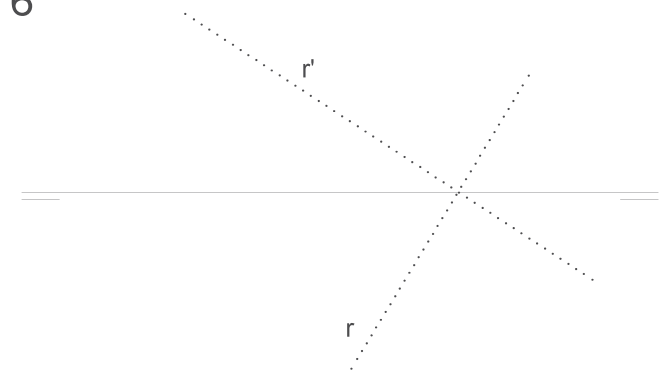

7

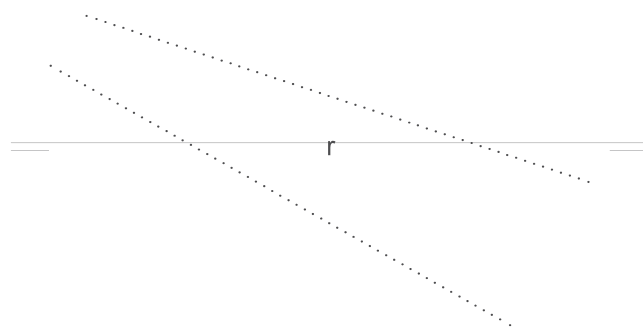

8

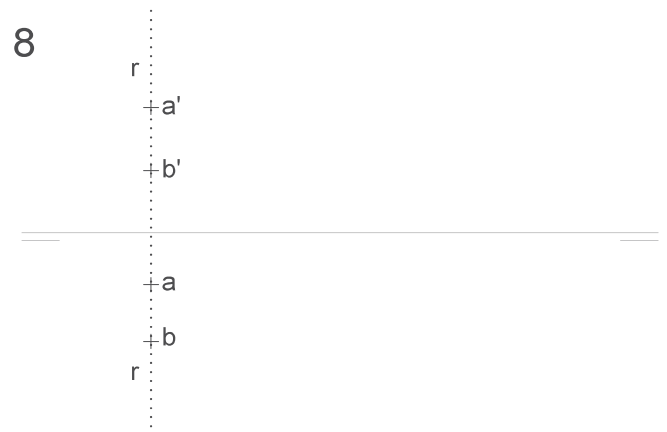

Alumno/a:

Conocida una traza y un punto A perteneciente al plano, hallar la otra traza

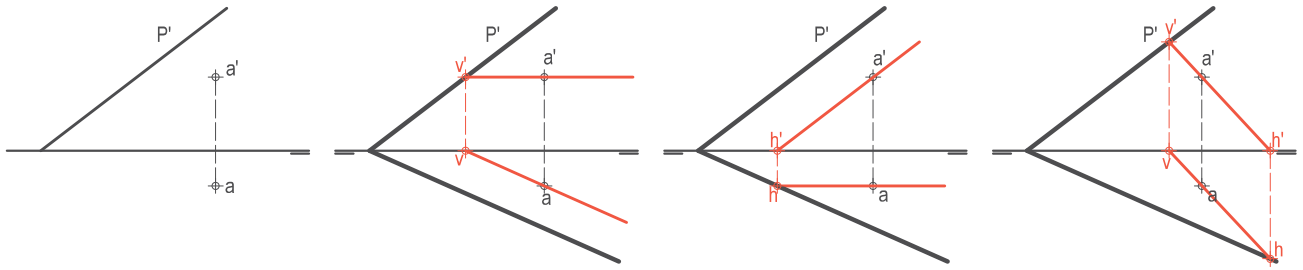

Con una recta horizontal

Con una recta frontal

Con una recta oblicua

1

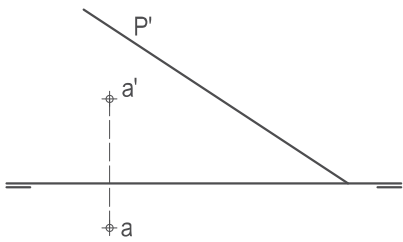

2

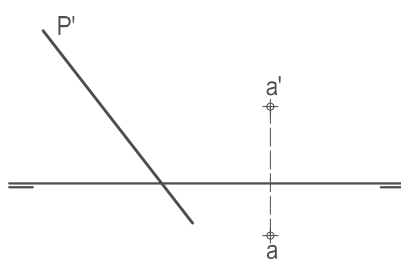

3

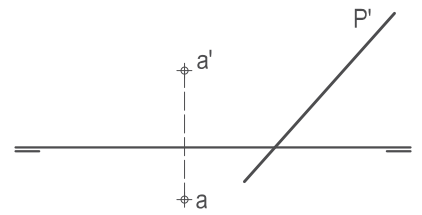

4

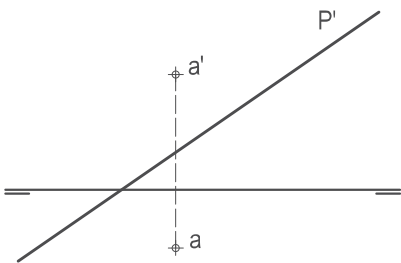

5

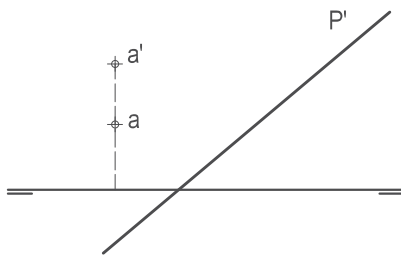

6

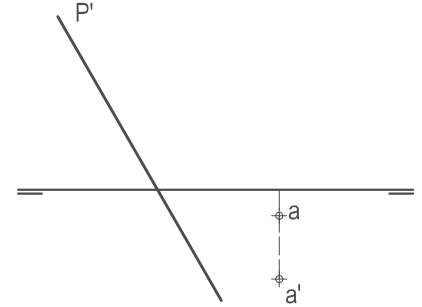

7

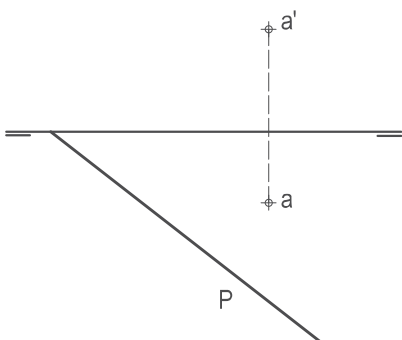

8

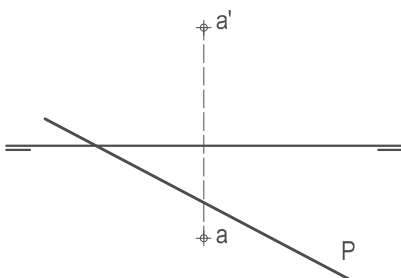

9

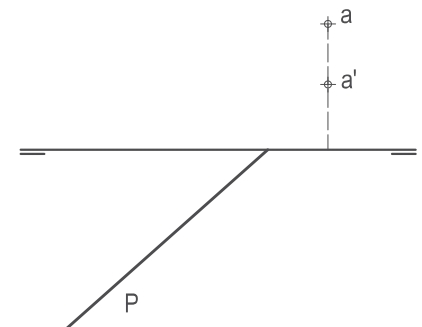

Alumno/a:

Cuando una recta R pertenece a un plano P las trazas de la recta están contenidas en las trazas del plano.

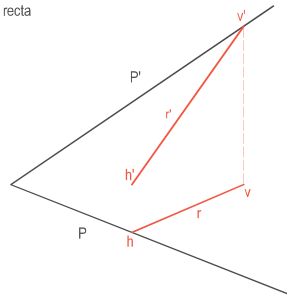

Conocida una de las proyecciones de una recta contenida en un plano, hallar la otra proyección

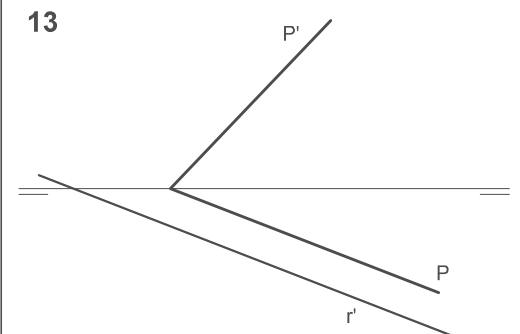
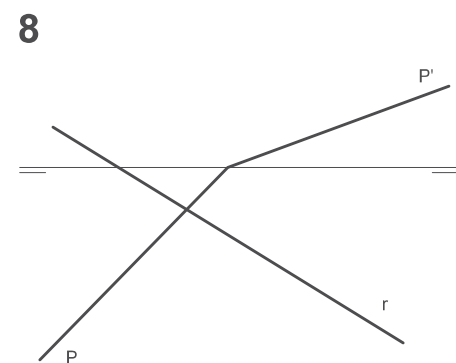
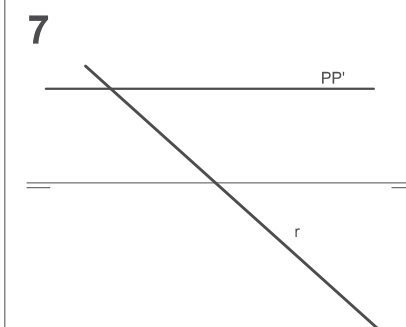
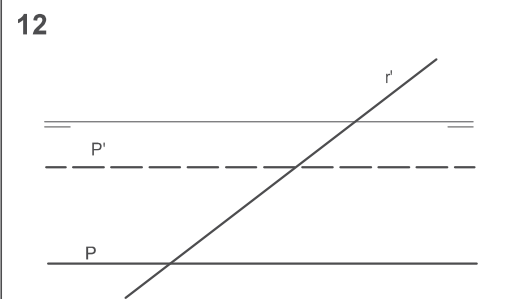
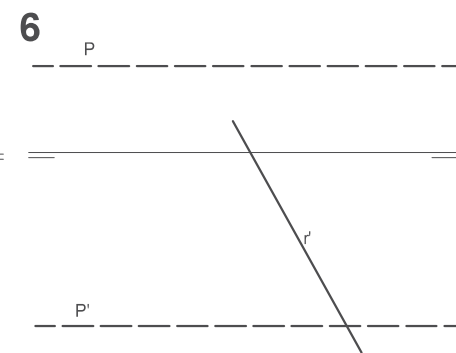
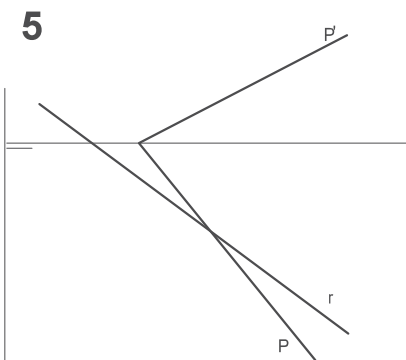
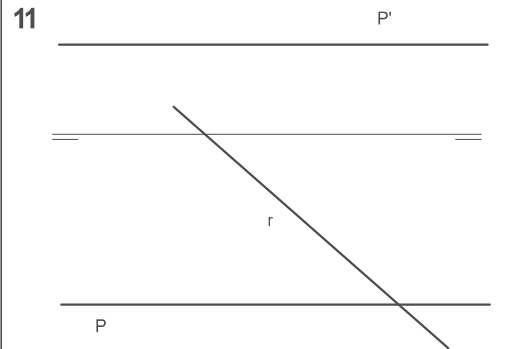
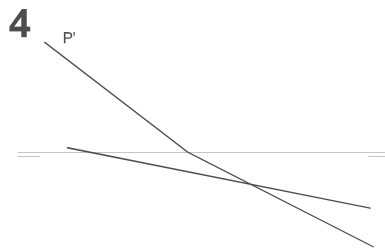
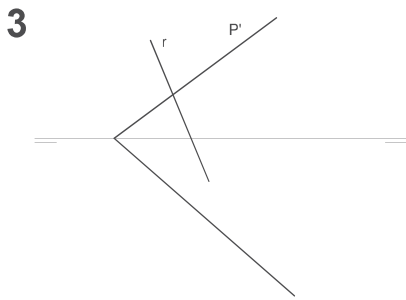
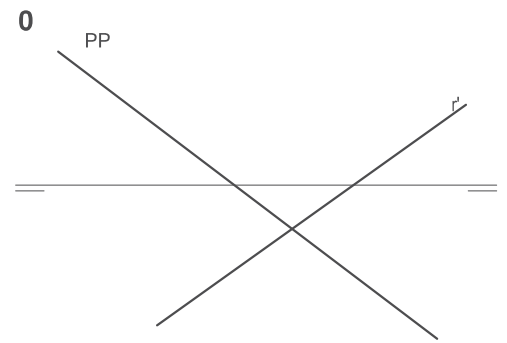
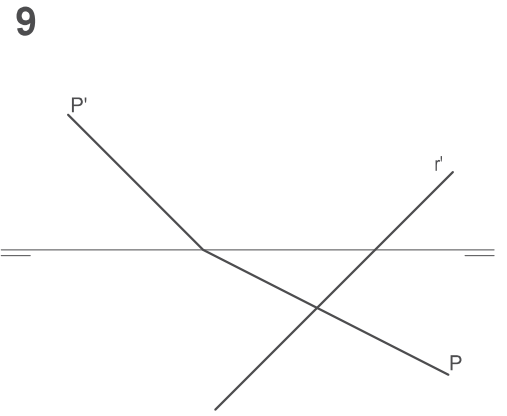
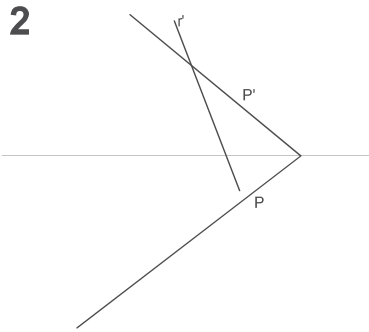
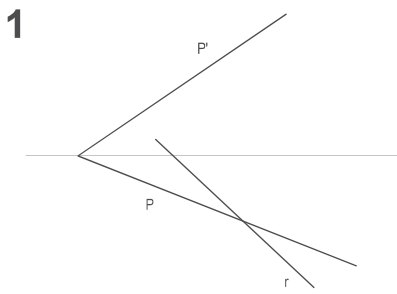

Alumno/a:

Dibujar las vistas (planta, alzado y perfil izquierdo) de las piezas representadas en isométrica.

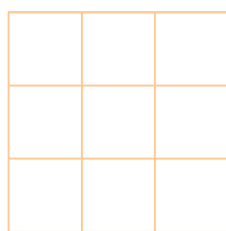
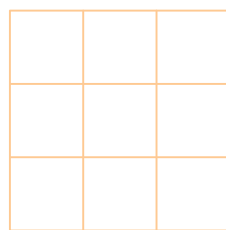
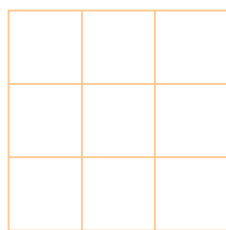
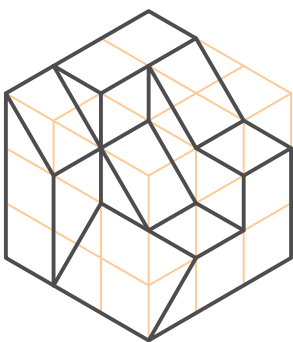
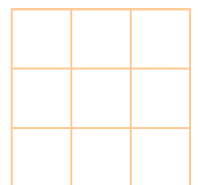
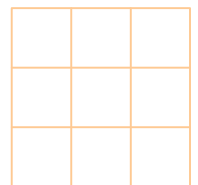
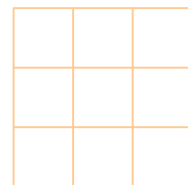
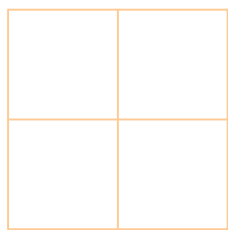
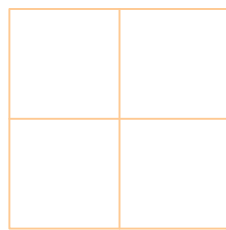
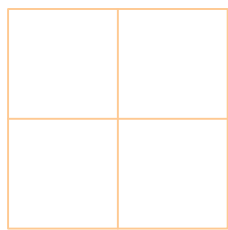
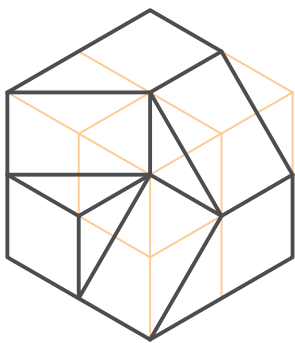
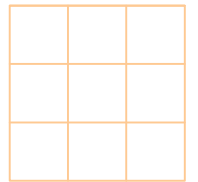
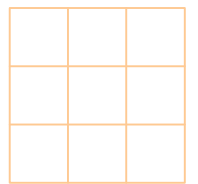
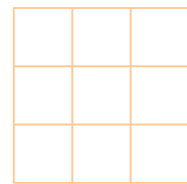
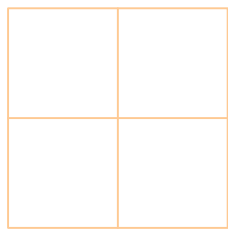
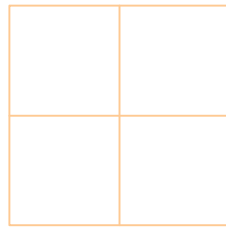
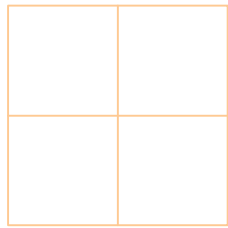
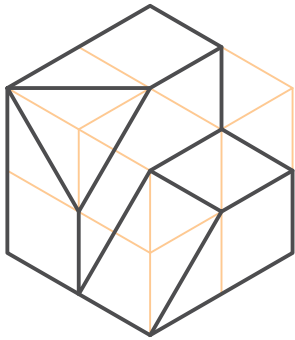

Alumno/a:

Dibujar las vistas (planta, alzado y perfil izquierdo) de las piezas representadas en isométrica.

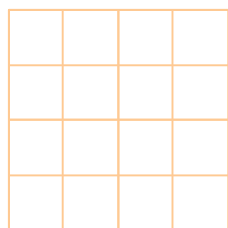
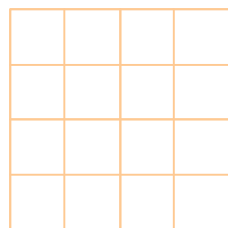
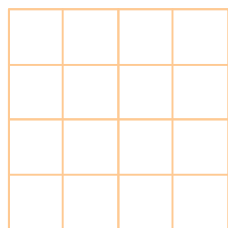
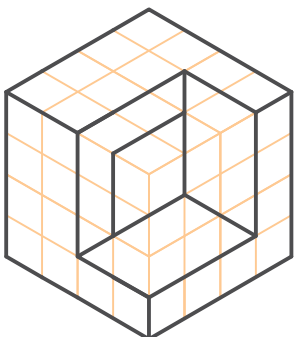
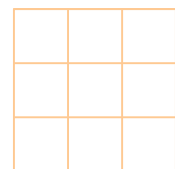
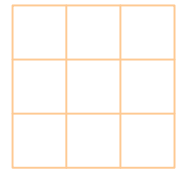
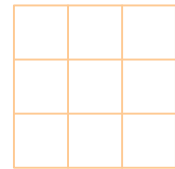
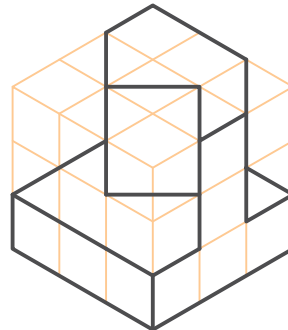
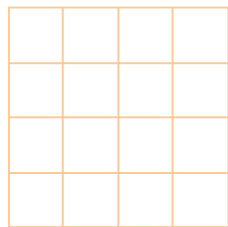
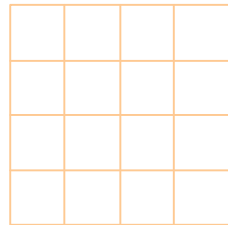
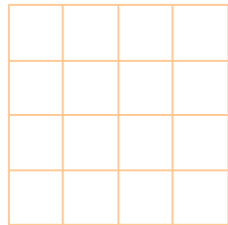
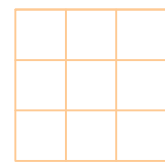
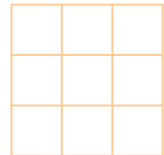
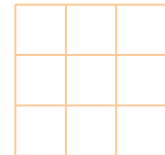
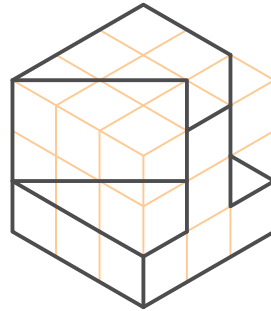
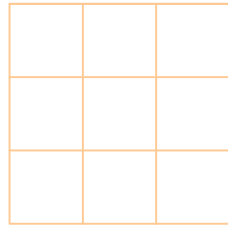
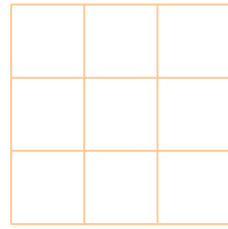
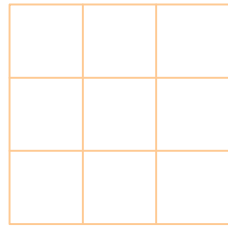
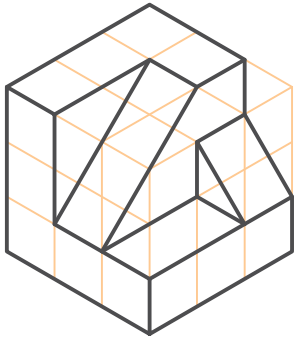

Alumno/a:

Dibujar las vistas (planta, alzado y perfil izquierdo) de las piezas representadas en isométrica.

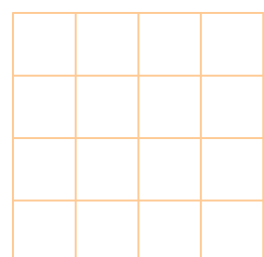
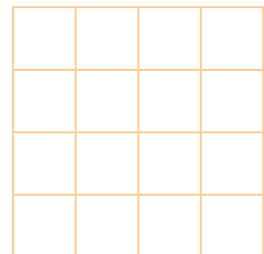
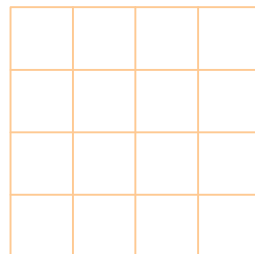
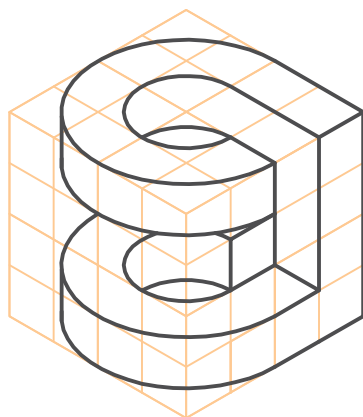
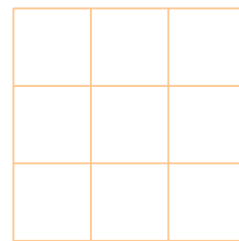
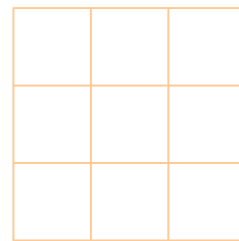
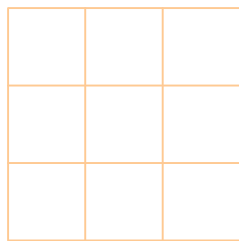
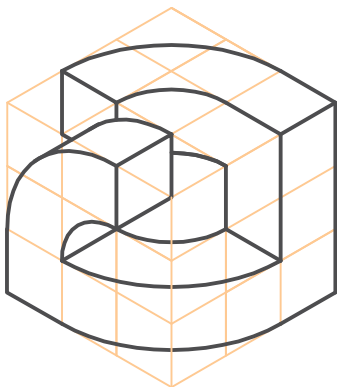
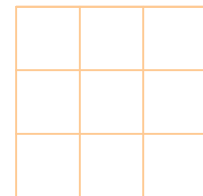
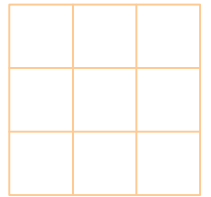
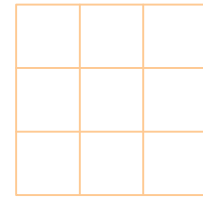
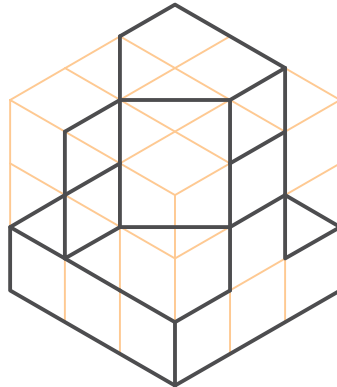
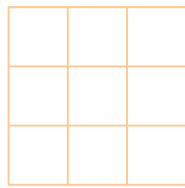
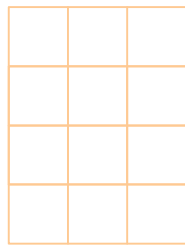
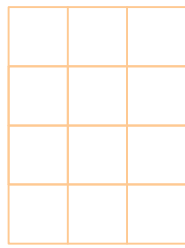
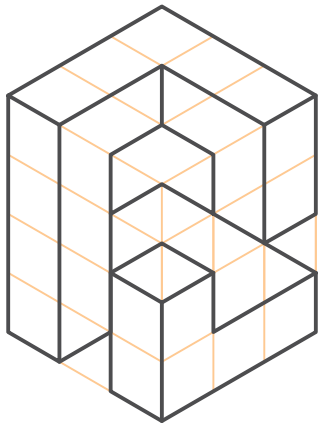

Alumno/a:

Realiza las las piezas
en folio aparte.

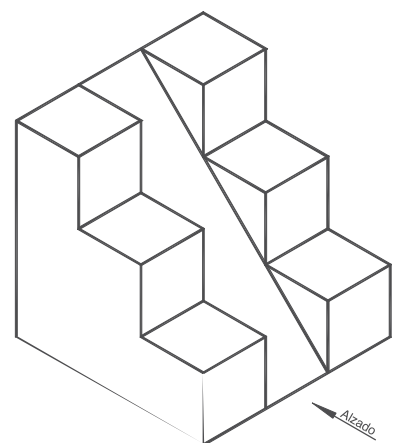
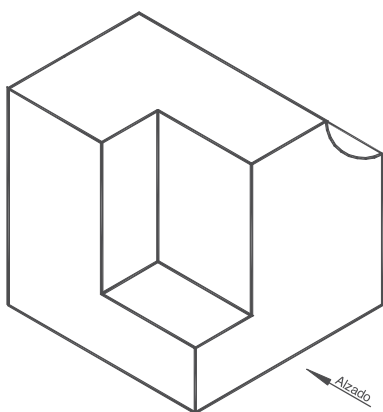
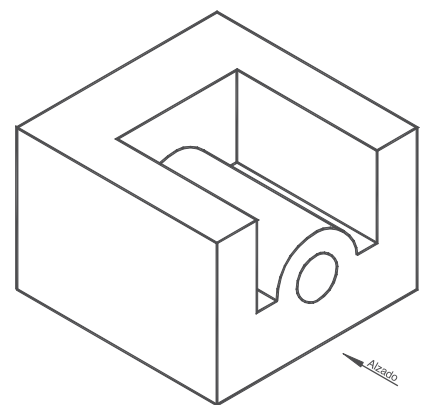
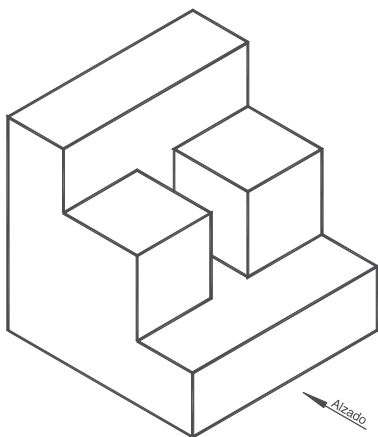
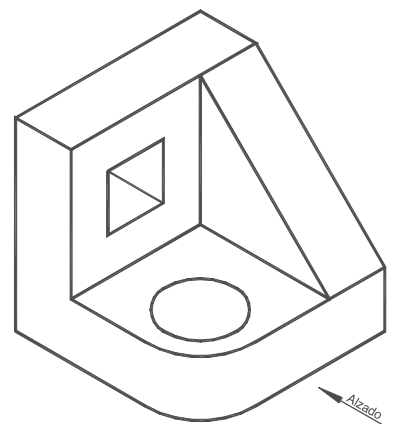
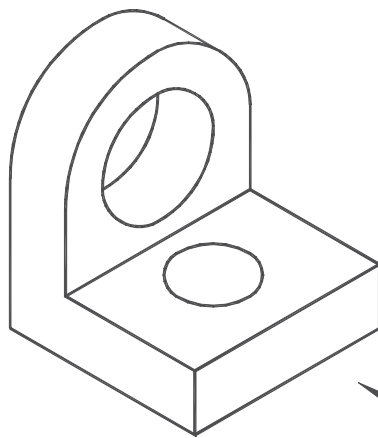
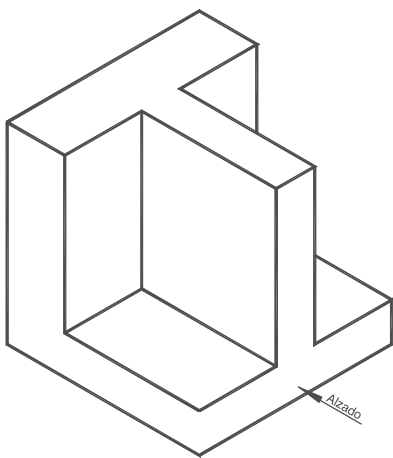
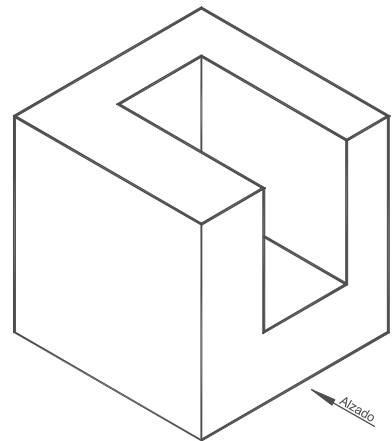
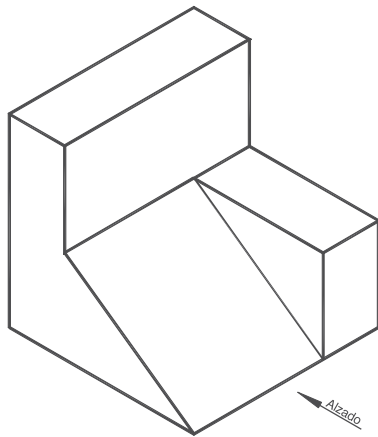
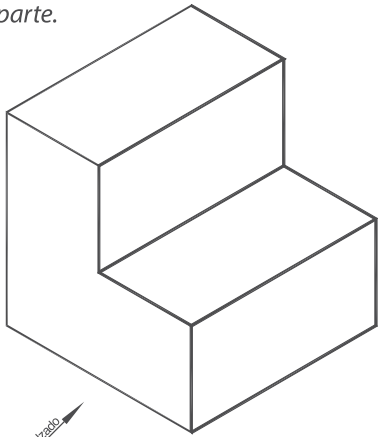

Alumno/a:

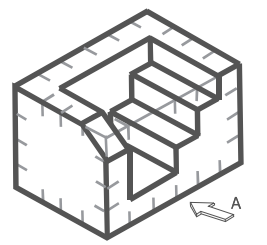
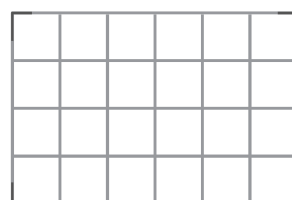
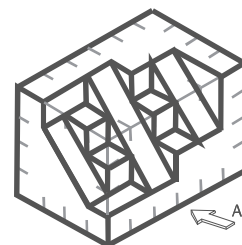
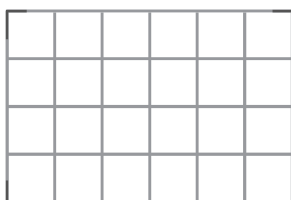
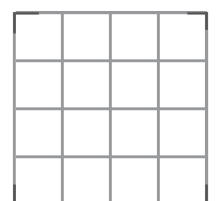
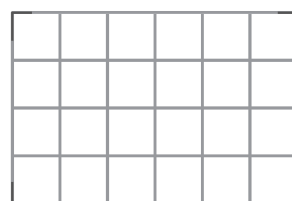
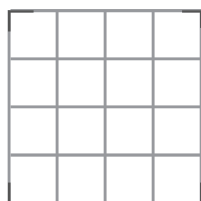
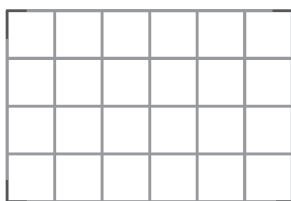
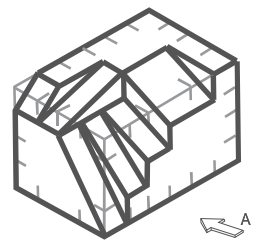
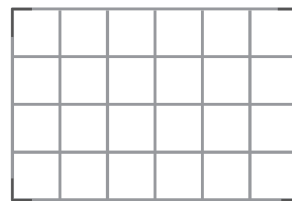
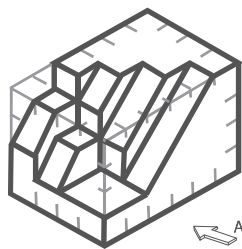
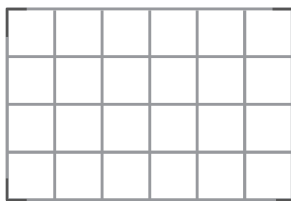
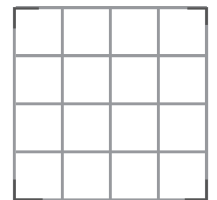
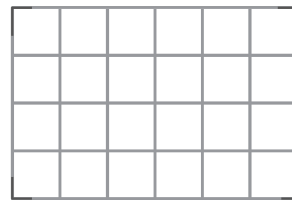
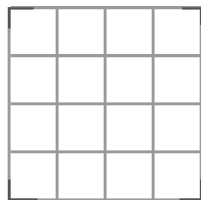
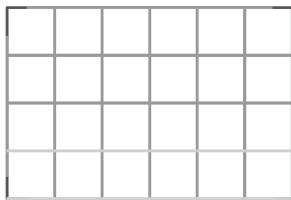
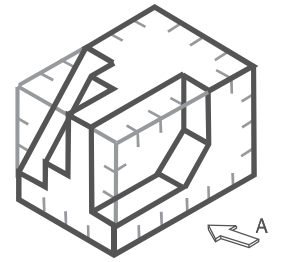
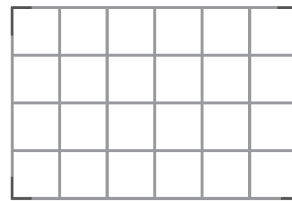
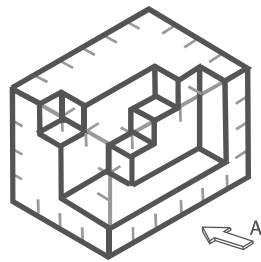
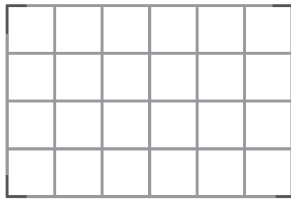
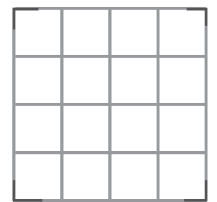
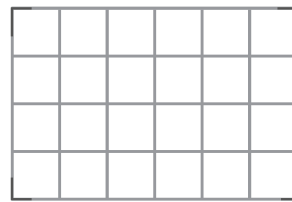
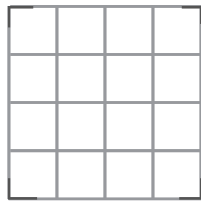
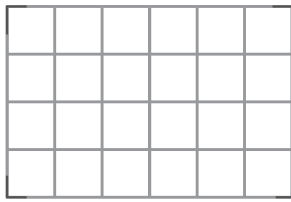
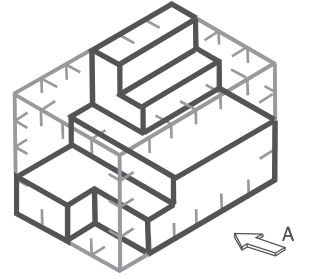
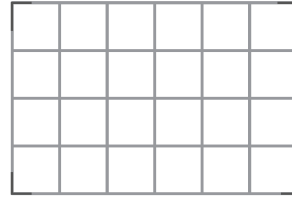
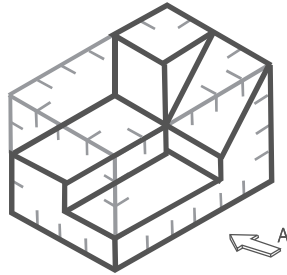
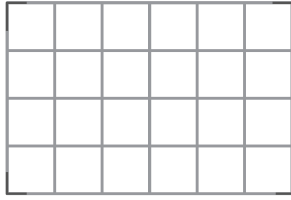
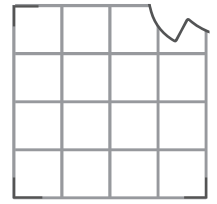
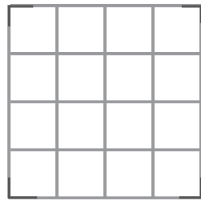
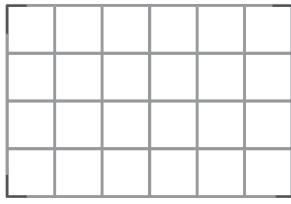

Alumno/a:

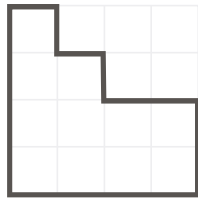
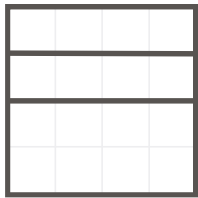
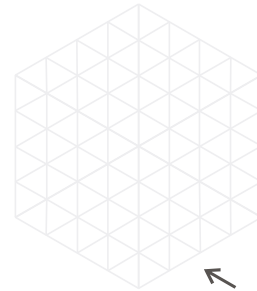
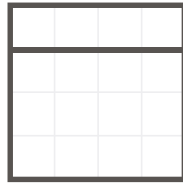
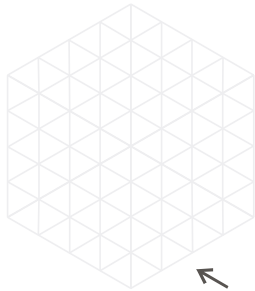
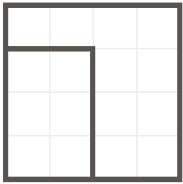
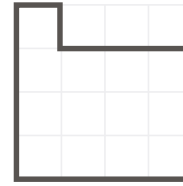
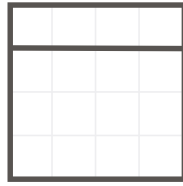
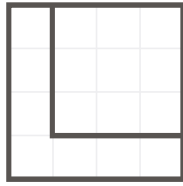
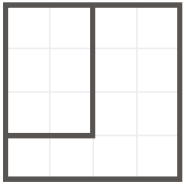

ALZADO

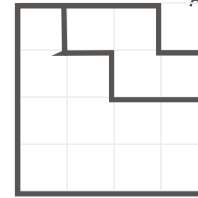
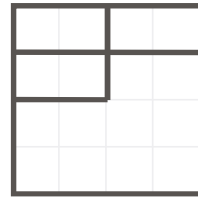

ALZADO

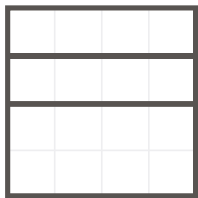

ALZADO

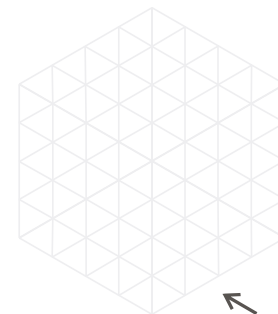
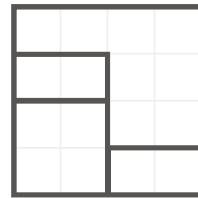

ALZADO

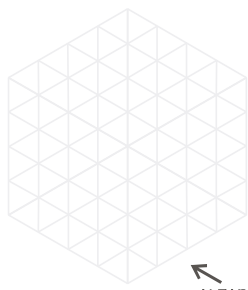
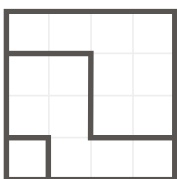
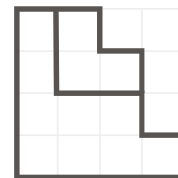
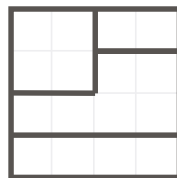
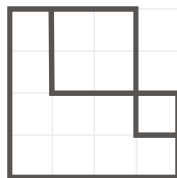
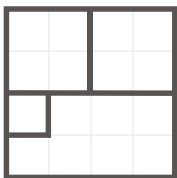

ALZADO

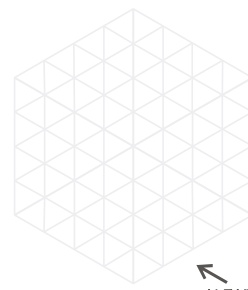
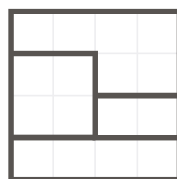

ALZADO

Alumno/a:

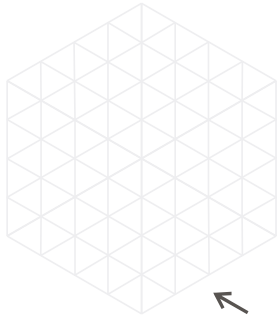
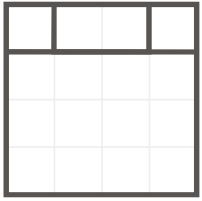
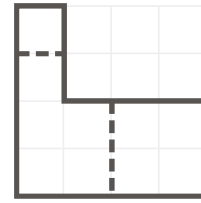
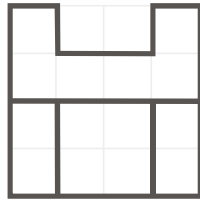
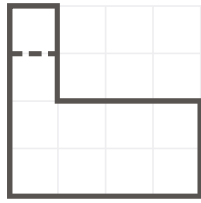
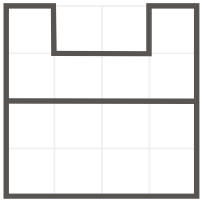

ALZADO

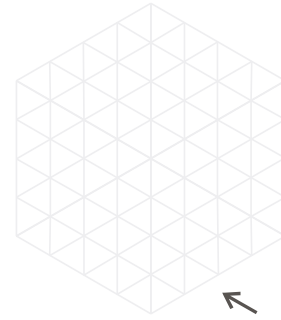
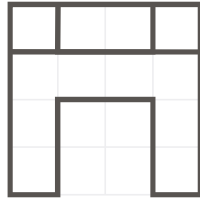

ALZADO

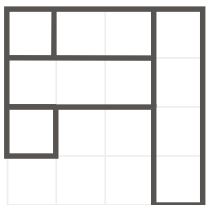
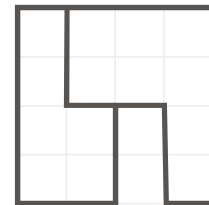
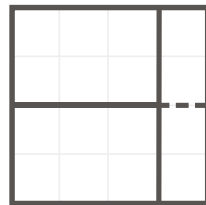
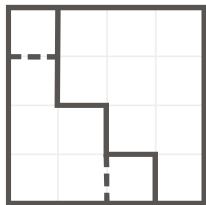
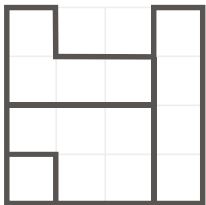

ALZADO

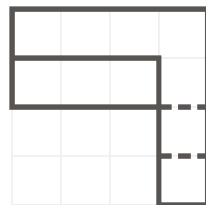

ALZADO

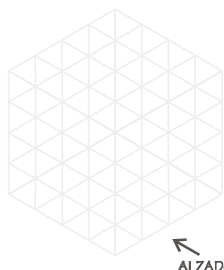
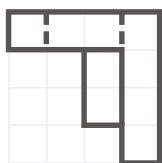
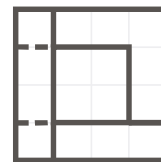
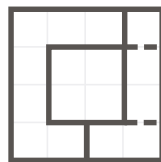
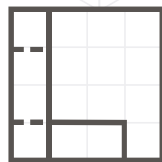
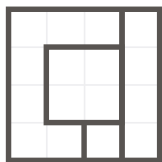

ALZADO

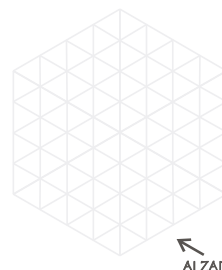
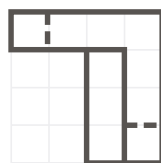

ALZADO

Alumno/a:

